

## RG 开启式螺杆压缩机

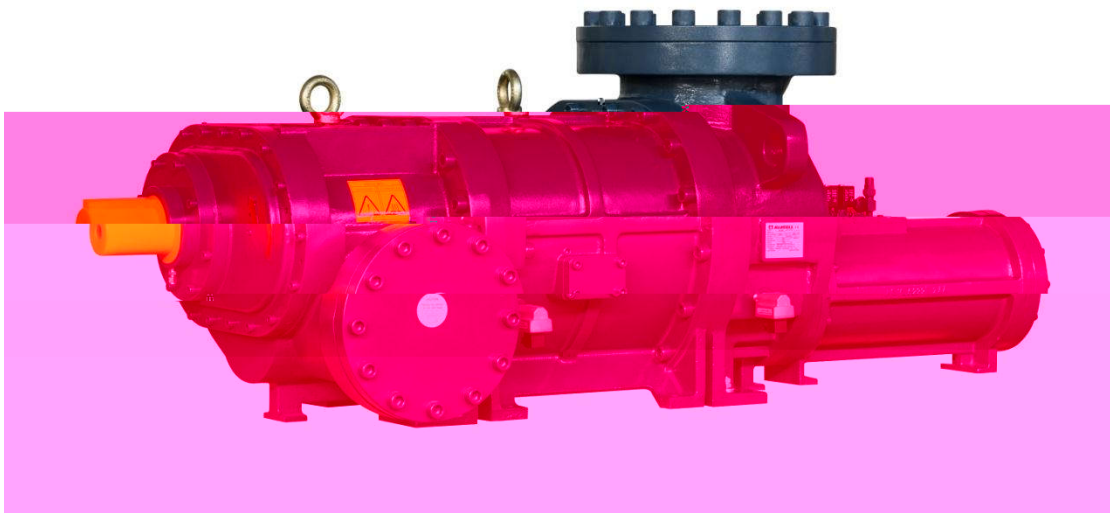







		RG-200	RG-410	RG-620	RG-830	RG1150	RG1270	RG1800	RG2280	RG2850
50Hz	m <sup>3</sup> /h	190	402	619	816	1146	1264	1761	2270	2851
	Rpm	4500					3600			
	Rpm	1500								
		25% 100%								
VI		2.6 5.1				2.6~5.6				
	kg	232	320	475	513	1000	1166	1600	1720	1900



---

RG200,R22								
		-50	-40	-30	-20	-10	0	10
	(kW)	19.9	35.1	56.2	86.2	128.1	184.7	259.2
30	(kW)	21.1	24.1	27.3	30.5	33.5	36.3	38.5
	(A)	36.1						



---

RG200,R717								
		-50	-40	-30	-20	-10	0	10
	(kW)	15.9	29.7	50.7	82.2	127.2	188.6	269.5
30	(kW)	21.5	23.8	26.9				



RG410,R22								
		-50	-40	-30	-20	-10	0	10
30	(kW)	42.4	74.7	119.5	183.2	272.1	392.5	550.7
	(kW)	43.9	50.1	56.7	63.4	69.7	75.4	80.1
	(A)	75.0	85.6	96.8	108.2	119.1	128.8	136.8
	COP	0.965	1.490	2.107	2.891	3.902	5.203	6.873
35	(kW)	38.7	70.0	113.0	174.0	259.3	375.2	528.1
	(kW)	46.7	54.2	61.7	68.9	75.5	81.1	85.4
	(A)	79.7	92.4	105.3	117.6	128.9	138.5	145.8
	COP	0.829	1.293	1.832	2.525	3.434	4.625	6.185
	(kW)	34.7						

40



---

RG410,R717



RG620,R22								
		-50	-40	-30	-20	-10	0	10
	(kW)	64.8	114.2	182.8	280.3	416.3	600.5	842.5
30	(kW)	65.9	75.2	85.1	95.1	104.6	113.1	120.2
	(A)	112.5	128.4	145.3	162.3	178.6		





---

RG830,R22

-50

-40

-30

-20

-10



---

RG830,R717

-50

-40



---

RG1270,R22

-50

-40



---

RG1270,R717								
		-50	-40	-30	-20	-10	0	10
30	(kW)	116.9	217.4	371.8	602.5	931.7	1381.6	1974.5
	(kW)	134.1	148.4	168.0	189.2	208.5	222.3	227.0
	(A)	228.9	253.3	286.8	323.0	356.0	379.6	387.5
	COP	0.872	1.465	2.214	3.184	4.468	6.214	8.698

---

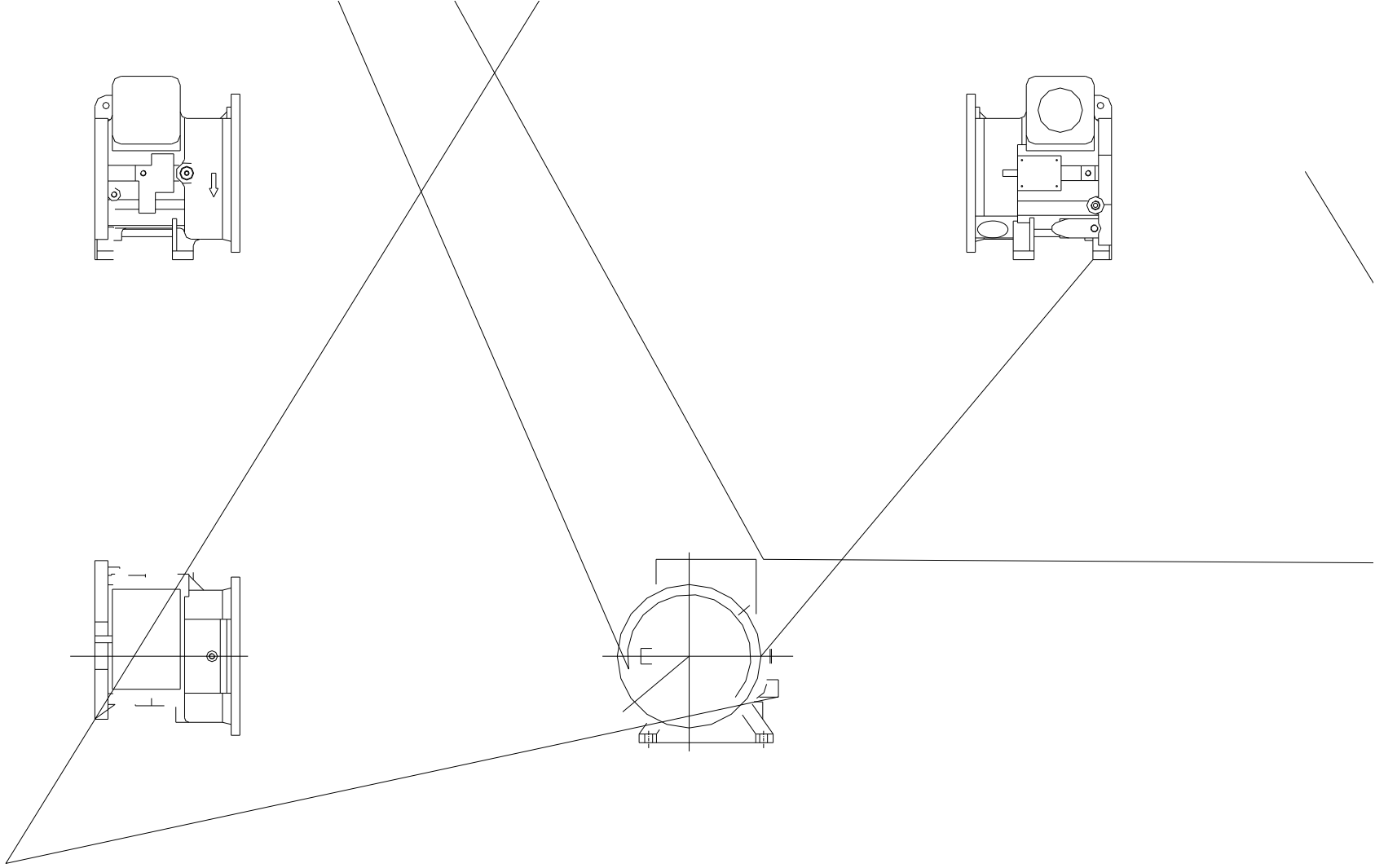
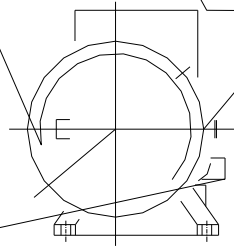
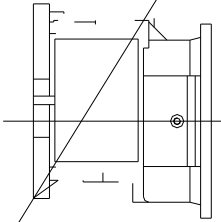
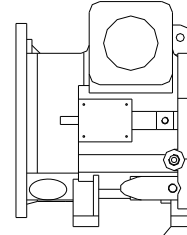
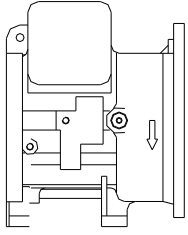

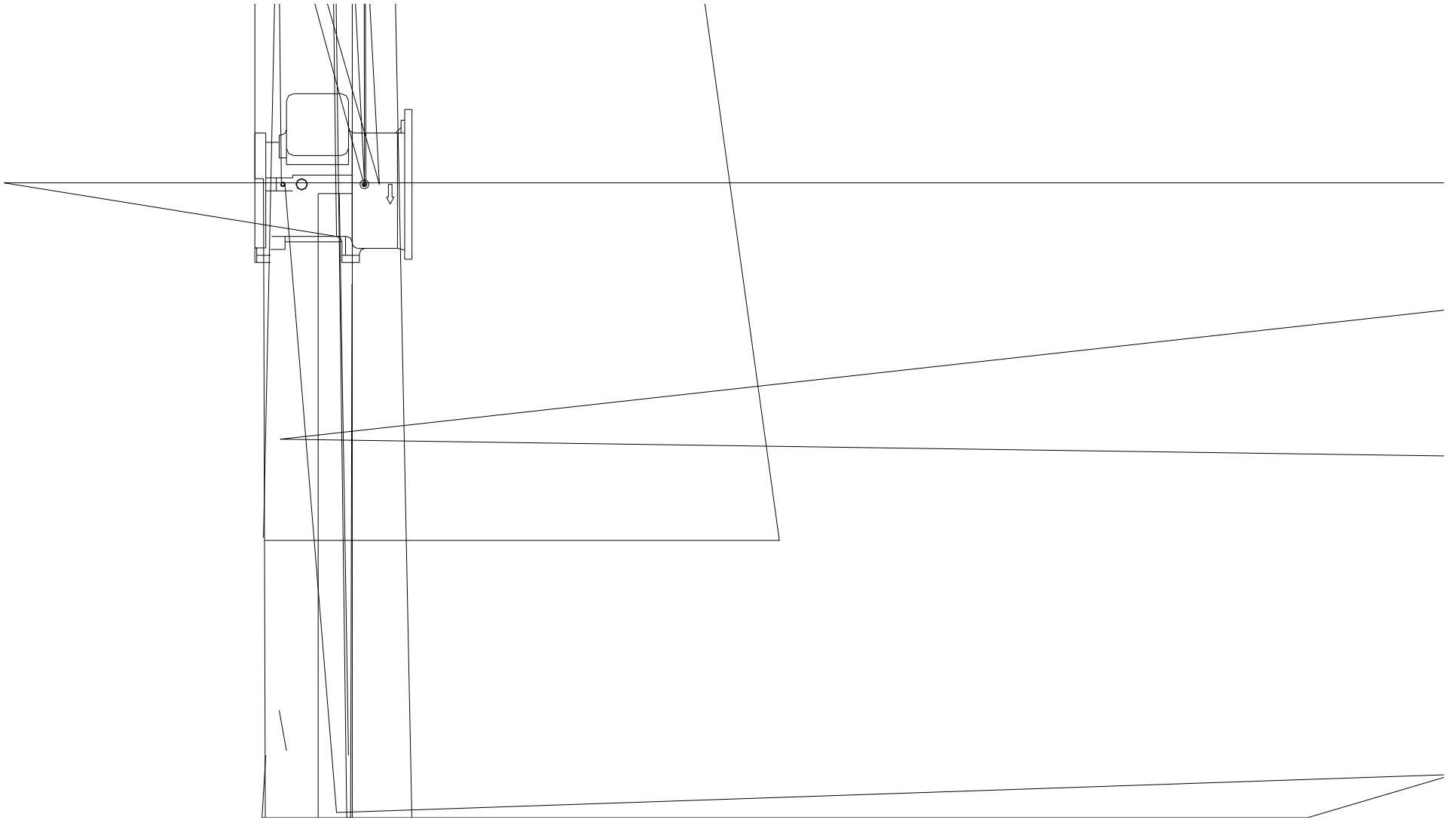

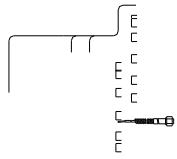

E  
E  
E

o



]

]

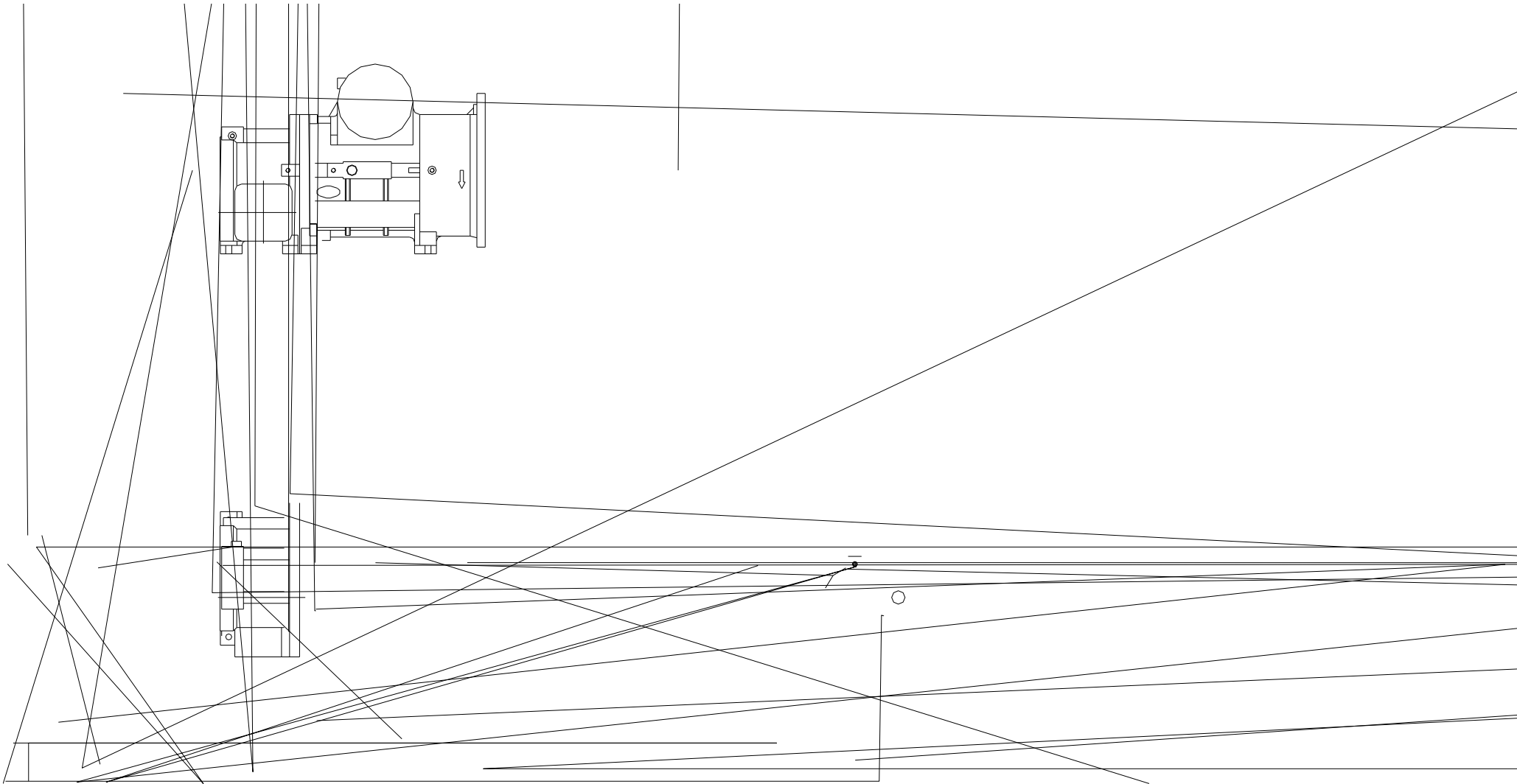

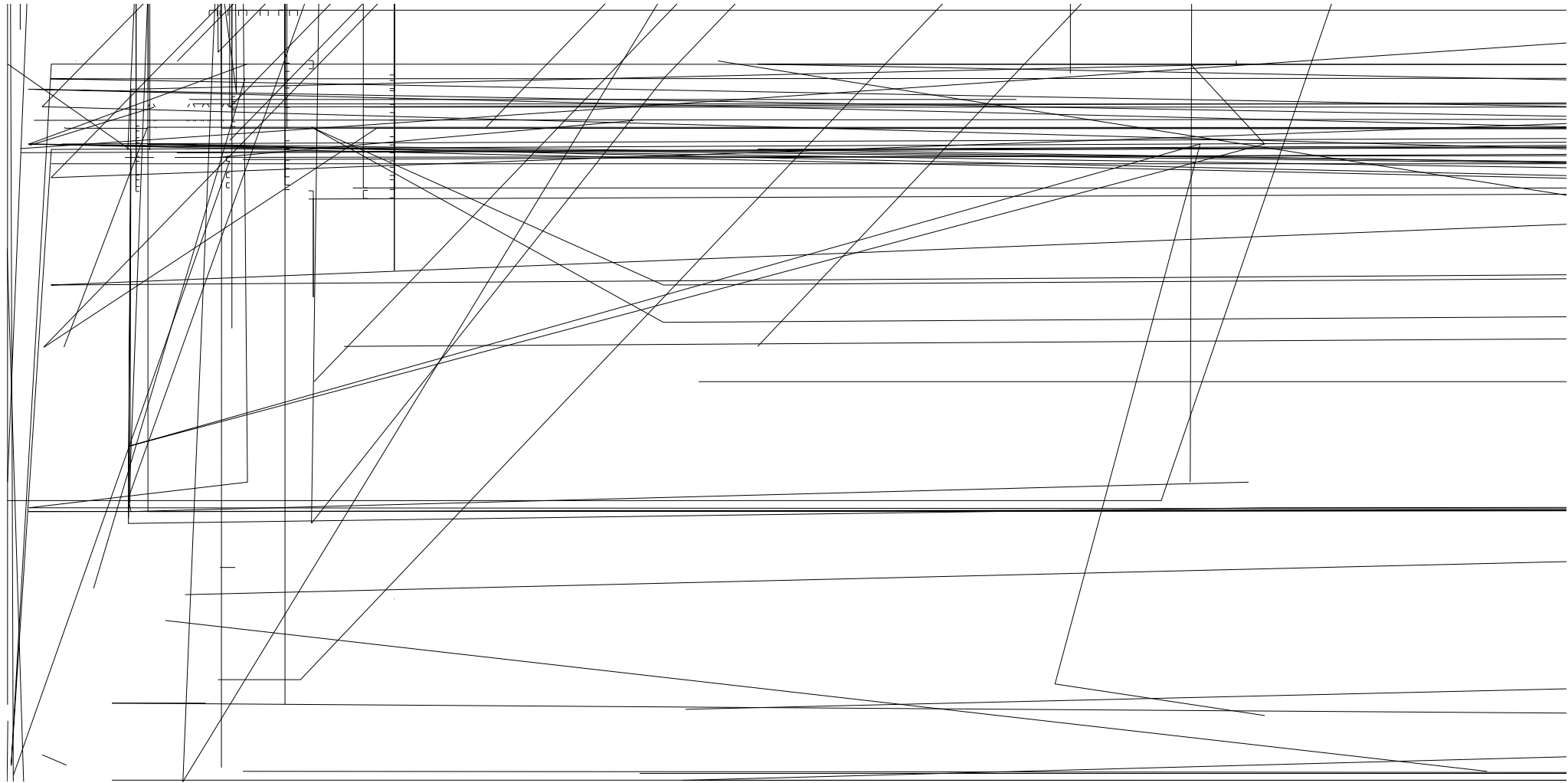



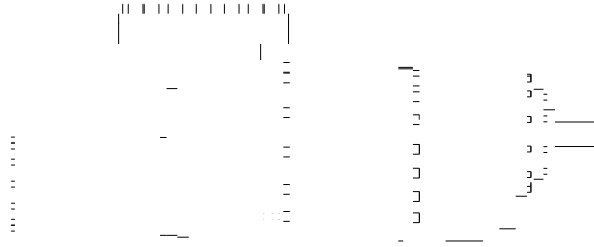

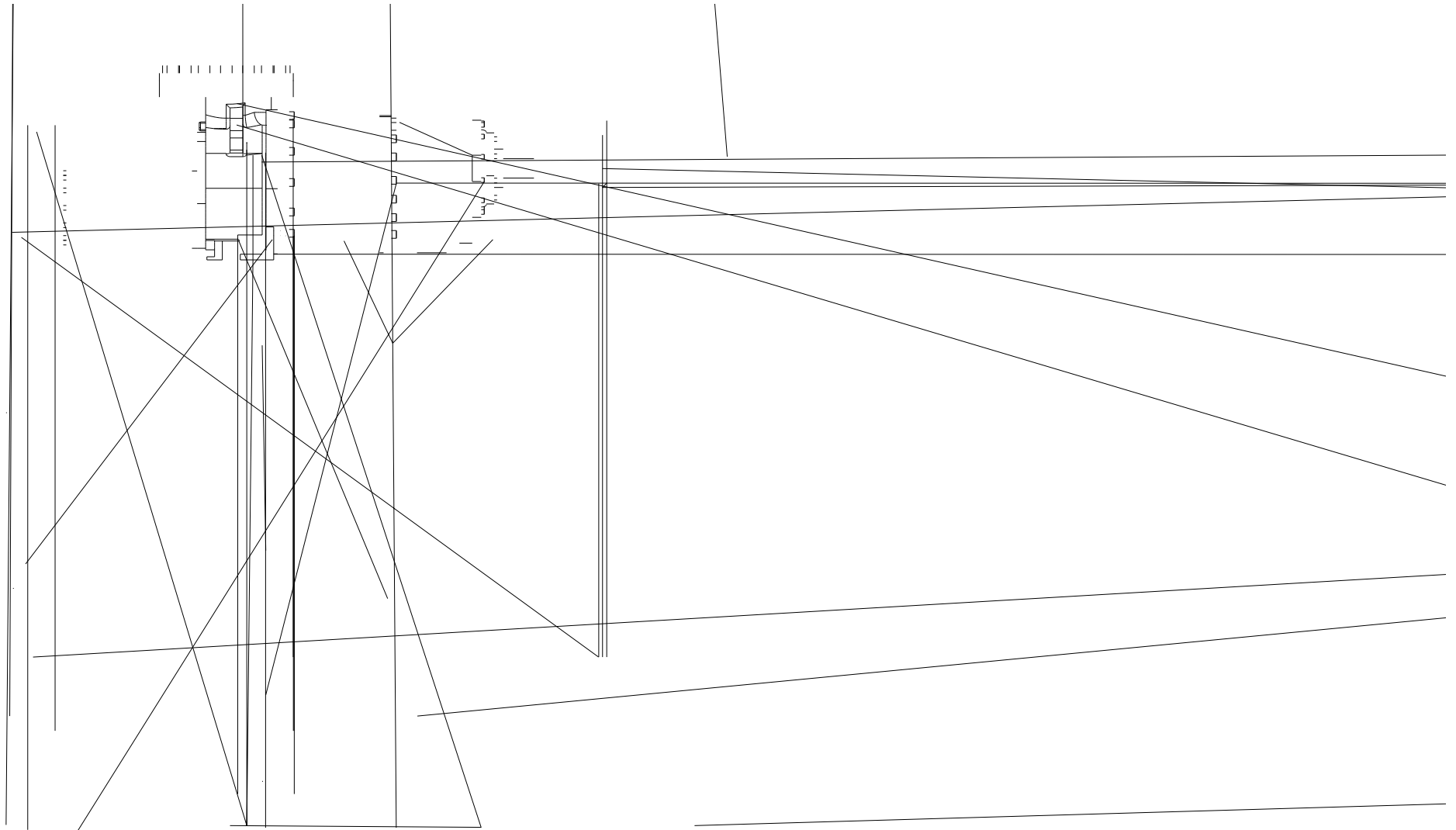





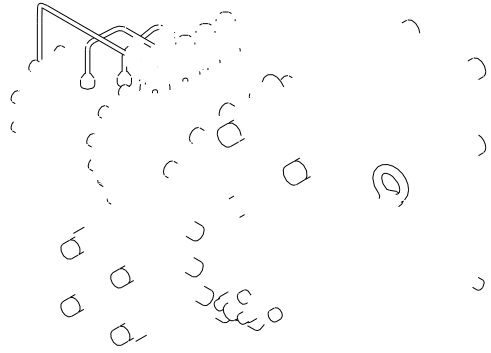

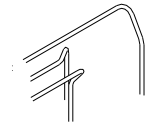

~  
!!    c c  
      c c

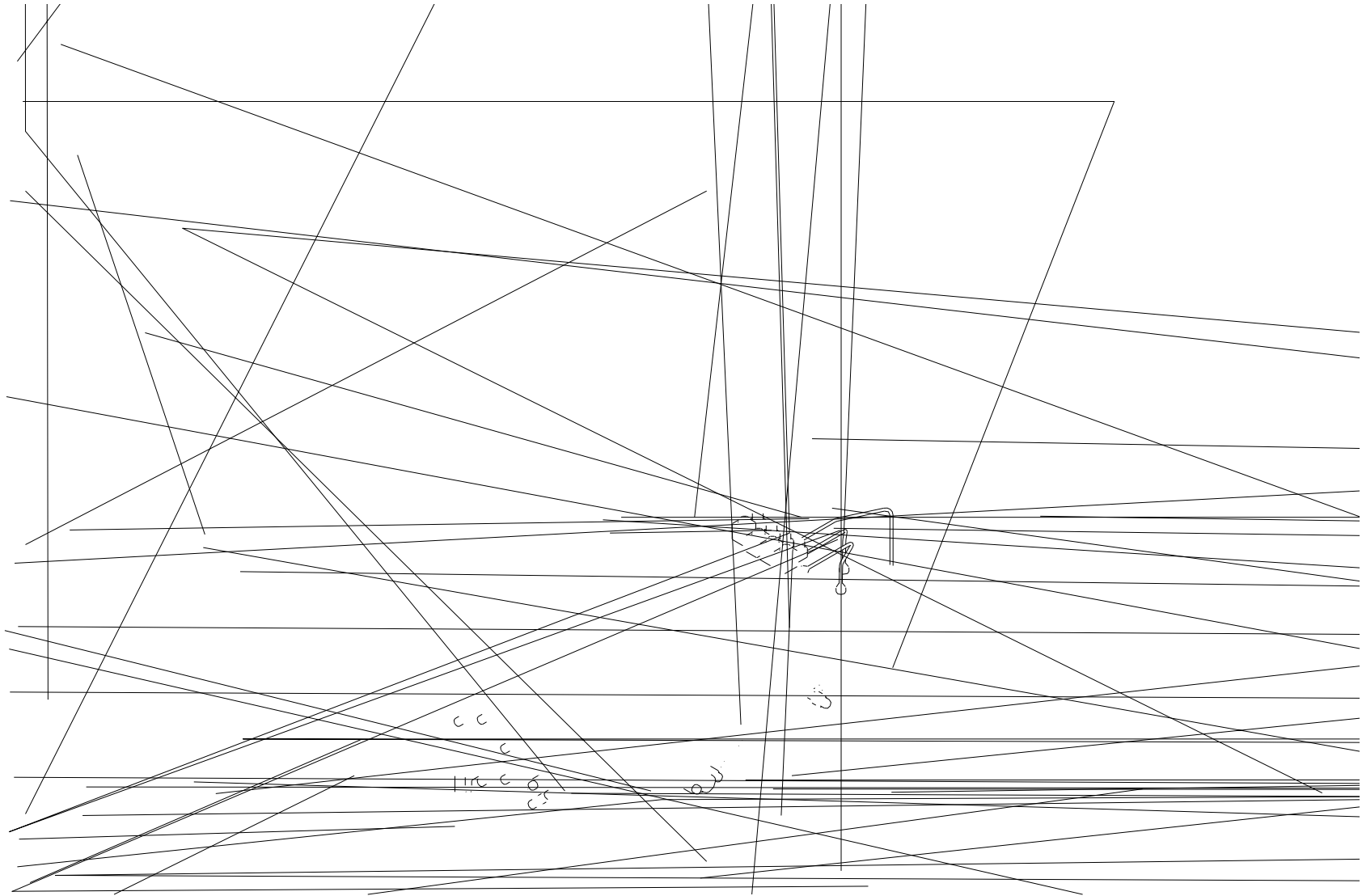









# 运行范